

ASSEMBLY INSTRUCTIONS

1: IDENTIFY ALL PIECES

PARTS (PIECES)

- A. SHELF (1)
- B. CLEAT (1)
- C. BOLT (2)
- D. WING (2)
- E. SCREW (2)

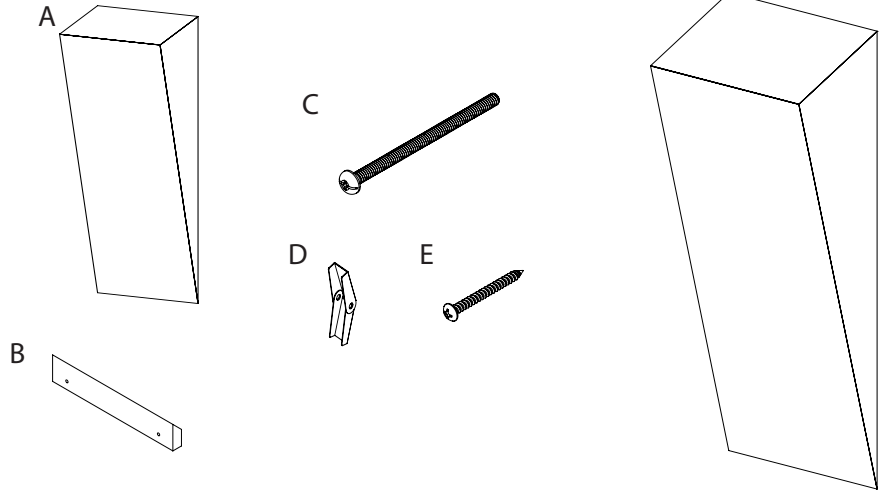

**PLEASE READ ALL INSTRUCTIONS
BEFORE ASSEMBLING**

FINISHED PRODUCT

2 PERSON ASSEMBLY RECOMMENDED

*TOOLS REQUIRED: 1 POWERDRILL WITH 5/8" DIAMETER DRILL BIT AND PHILLIPS HEAD SCREWDRIVER (NOT INCLUDED)

**SCREW(PART F) MAY NOT BE NECESSARY AND IS INCLUDED IN CASE MOUNTING POSITION INTERSECTS STUD IN WALL.

2: DRILL MOUNTING HOLES

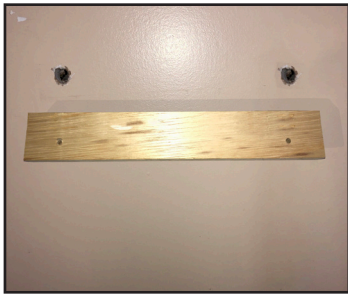

Unless Mounting into a stud, drill two 5/8" diameter holes that match the distance of the two holes in the Cleat(B) when it is in the desired position on wall. These holes will be used to mount the cleat.

Note : If mounting into a stud in the wall, use a Screw(F) to directly drill into the stud. If mounting into a stud, do not drill a 5/8" hole for that side.

3: INSERT BOLT INTO CLEAT

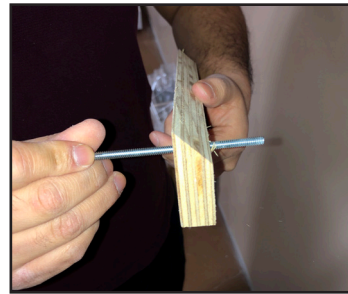

Insert both Bolts(C) into the holes in the Cleat(B) in the orientation as shown.

Note : The heads of the bolts must be on the taller face of the cleat when it is inserted.

4: SCREW WINGS ONTO BOLTS

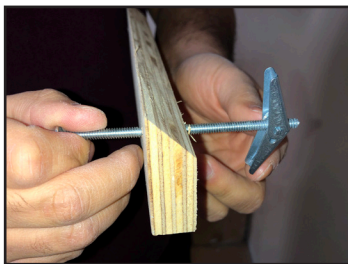

Screw the Wings(D) onto the Bolts(C) as shown. Screw the wing about 1/3 of the way up the bolt.

Note : The wing should be positioned such that when it is pinched, the wings fold towards the cleat, as shown in the bottom picture to the left.



5: INSERT BOLTS INTO WALL

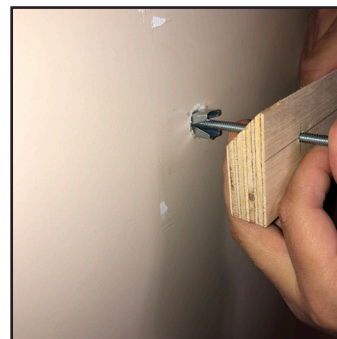

With the wings screwed on, insert the bolts into the holes drilled in Step 2. Pinch the wings and insert them into the holes. Push Bolt into hole until wing opens on other side of drywall.

Note : When wing opens, you cannot pull the bolt out of wall and you cannot reposition the cleat.

Note : Ensure the short face of the cleat is facing the wall.

ASSEMBLY INSTRUCTIONS

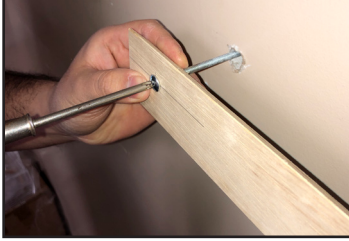
6: TIGHTEN BOLTS

While pulling the cleat towards you, tighten the bolts with a screwdriver until cleat is firmly mounted against wall.

Note : If the cleat is not pulled towards you, the wing will spin freely inside the wall and the bolt will not tighten.

Note : It is easiest to keep alternating the bolt being tightened, rather than tightening one bolt completely and then tightening the other.

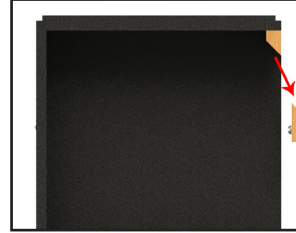
**7: PLACE SHELF ON CLEAT**

Place the cleat found on the back of the Shelf(A) over the Cleat(B) that was just mounted. The cleats should meet such that the angled faces of each are in contact with one another.

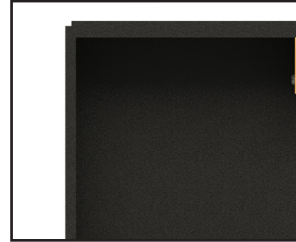

Note : Back of shelf should sit flush against the wall when mounted against cleat.

8. FINISHED PRODUCT

Wooden Wedge Wall Mount Shelf is assembled and ready to use.